

• General Description

It combines trench MOSFET technology with a low resistance package to provide extremely low  $R_{DS(ON)}$ .

• Features

- Low  $R_{DS(ON)}$  to minimize conductive loss
- Low Gate Charge for fast switching
- Half-Bridge - N-channel

• Application

- BLDC Motor driver
- DC-DC

• Product Summary

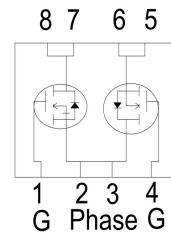

$V_{DS} = 40V$   
 $R_{DS(ON)} = 4.1m\Omega$   
 $I_D = 60A$

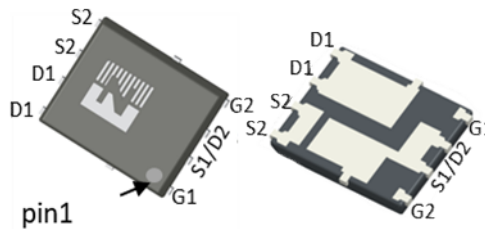

DFN5\*6



• Ordering Information:

Part NO.	ZMD68410N
Marking	ZMD68410
Packing Information	REEL TAPE
Basic ordering unit (pcs)	3000

• Absolute Maximum Ratings ( $T_C=25^\circ C$ )

Parameter	Symbol	Conditions	Value	Unit
Drain-Source Voltage	$V_{DS}$		40	V
Gate-Source Voltage	$V_{GS}$		$\pm 20$	V
Continuous Drain Current	$I_D$	$T_C=25^\circ C$	60	A
	$I_D$	$T_C=75^\circ C$	56	A
	$I_D$	$T_C=100^\circ C$	49	A
Pulsed Drain Current	$I_{DM}$	Pulsed; $t_p \leq 10 \mu s$ ; $T_{mb} = 25^\circ C$ ;	240	A
Total Power Dissipation	$P_D$	$T_C=25^\circ C$	39	W
Total Power Dissipation	$P_D$	$T_A=25^\circ C$	3.3	W
Operating Junction Temperature	$T_J$		-55 to +175	$^\circ C$
Storage Temperature	$T_{STG}$		-55 to +175	$^\circ C$
Single Pulse Avalanche Energy	$E_{AS}$	$L=0.1mH, V_{GS}=10V, R_g=25\Omega,$	35	mJ
		$L=0.5mH, V_{GS}=10V, R_g=25\Omega,$	73.5	mJ
ESD Level (HBM)			CLASS 2	

**•Thermal resistance**

Parameter	Symbol	Min.	Typ.	Max.	Unit
Thermal resistance, junction - case	$R_{thJC}$		-	3.8	°C/W
Thermal resistance, junction-ambient <sup>①</sup>	$R_{thJA}$		-	45	°C/W
Soldering temperature	$T_{sold}$		-	260	°C

**•Electronic Characteristics**

Parameter	Symbol	Condition	Min.	Typ.	Max.	Unit
Drain-Source Breakdown Voltage	$BV_{DSS}$	$V_{GS} = 0V, I_D = 250\mu A$	40			V
Gate Threshold Voltage	$V_{GS(TH)}$	$V_{GS} = V_{DS}, I_D = 250\mu A$	2.0	2.7	3.2	V
Drain-Source Leakage Current	$I_{DSS}$	$V_{GS} = 0V, V_{DS} = 40V$			1.0	$\mu A$
Gate- Source Leakage Current	$I_{GSS}$	$V_{GS} = \pm 20V, V_{DS} = 0V$			100	nA
Static Drain-source On Resistance	$R_{DS(ON)}$	$V_{GS} = 10V, I_D = 14A$		4.1	5.0	m $\Omega$
Forward Transconductance	$g_{FS}$	$V_{DS} = 5V, I_{SD} = 4A$		7.0		S
Diode Forward Voltage	$V_{FSD}$	$V_{GS} = 0V, I_{SD} = 14A$			1.3	V

**•Dynamic characteristics**

Parameter	Symbol	Condition	Min.	Typ.	Max.	Unit
Input capacitance	$C_{iss}$	$f = 1MHz, V_{DS} = 25V$	-	908	-	pF
Output capacitance	$C_{oss}$		-	244	-	
Reverse transfer capacitance	$C_{rss}$		-	10	-	
Gate Resistance	$R_g$	$f = 1MHz$	-	1.2		$\Omega$
Total gate charge	$Q_g$	$V_{DD} = 15V, I_D = 20A, V_{GS} = 10V$	-	14	-	nC
Gate - Source charge	$Q_{gs}$		-	3.2	-	
Gate - Drain charge	$Q_{gd}$		-	3.5	-	
Turn-ON Delay time	$t_{D(on)}$	$V_{GS} = 10V, V_{DS} = 15V, R_G = 3.3\Omega, I_D = 20A$	-	4.5	-	ns
Turn-ON Rise time	$t_r$		-	2	-	ns
Turn-Off Delay time	$t_{D(off)}$		-	8	-	ns
Turn-Off Fall time	$t_f$		-	4	-	ns
Reverse Recovery Time	$t_{RR}$	$V_{DD} = 20V, dI_S/dt = 100A/\mu s, I_S = 20A$	-	26	-	ns
Reverse Recovery Charge	$Q_{RR}$		-	12	-	nC

Fig.1 Gate-Charge Characteristics

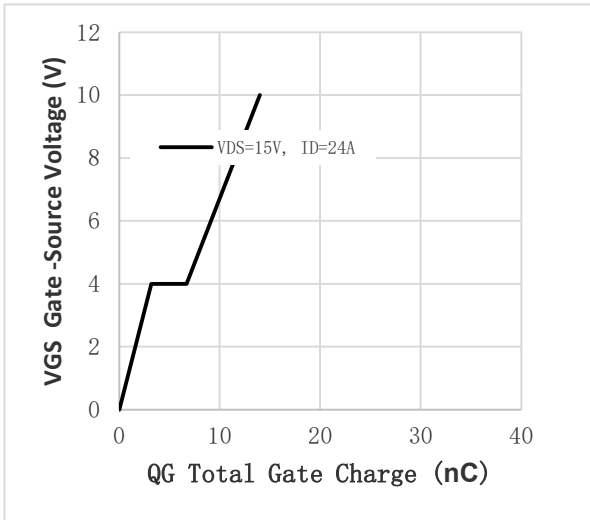

Fig.2 Capacitance Characteristics

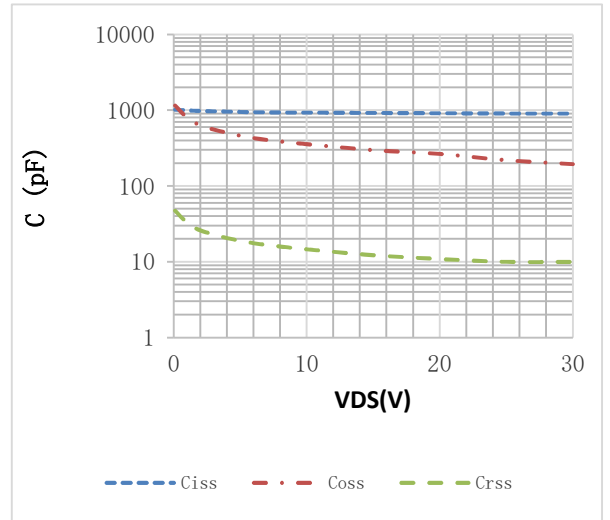

Fig.3 Power Dissipation

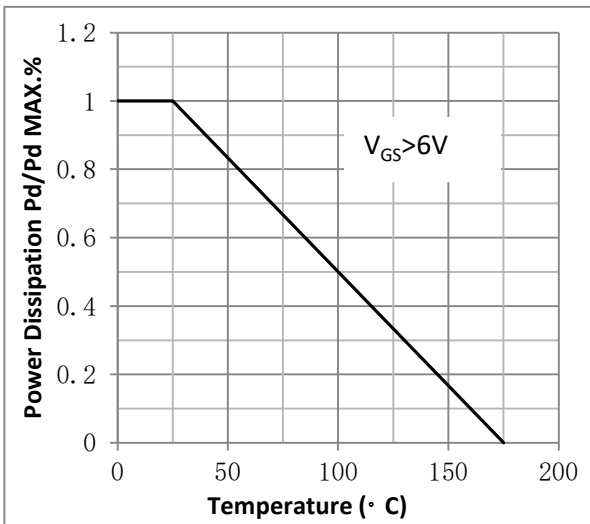

Fig.4 Typical output Characteristics

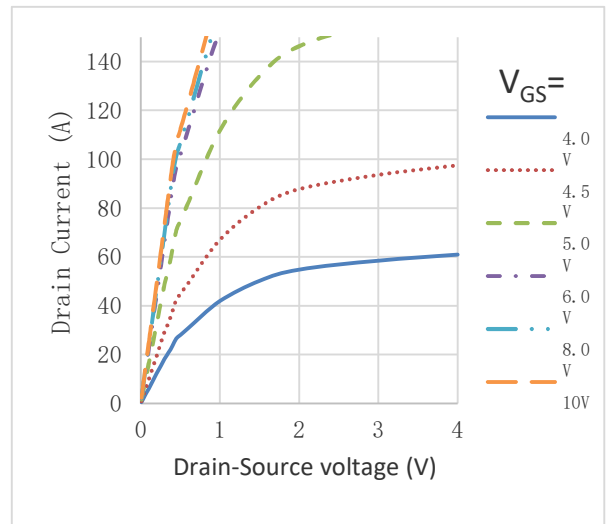

Fig.5 Threshold Voltage V.S Junction Temperature

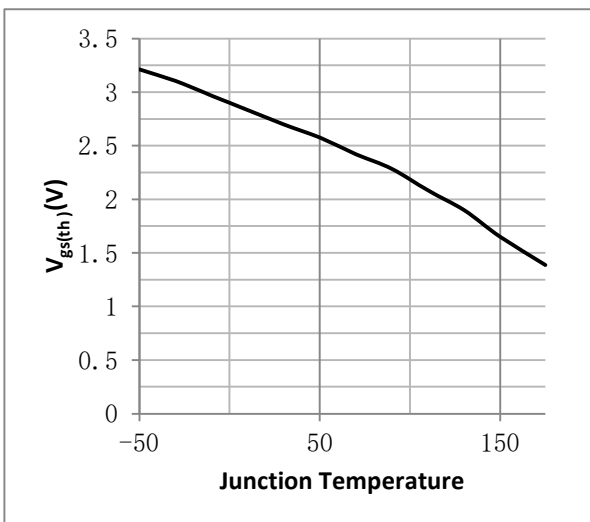

Fig.6 Resistance V.S Drain Current

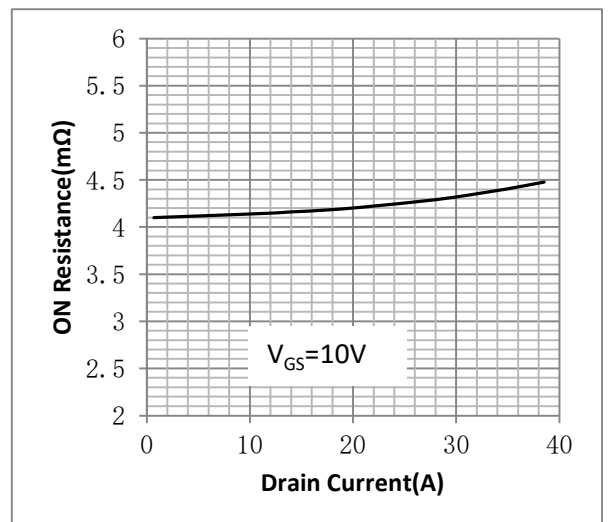

Fig.7 On-Resistance VS Gate Source Voltage

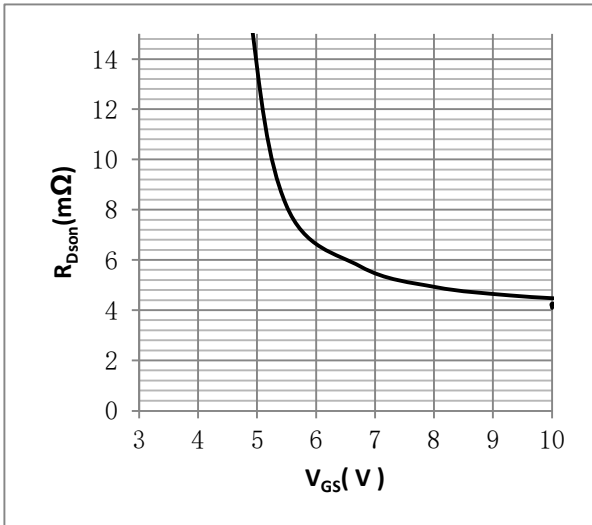

Fig.8 On-Resistance V.S Junction Temperature

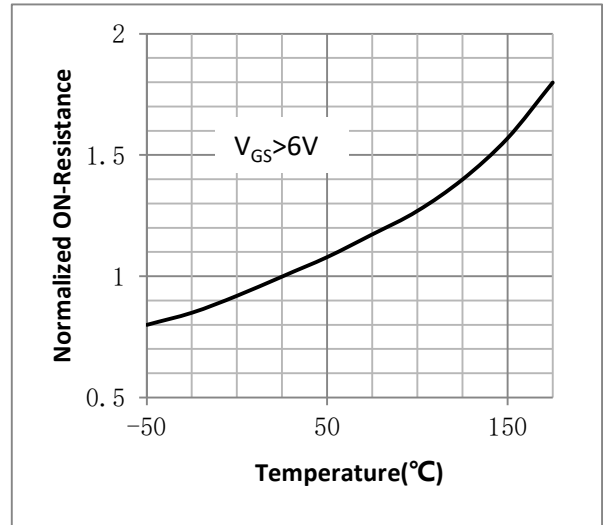

Figure 9. Diode Forward Voltage vs. Current

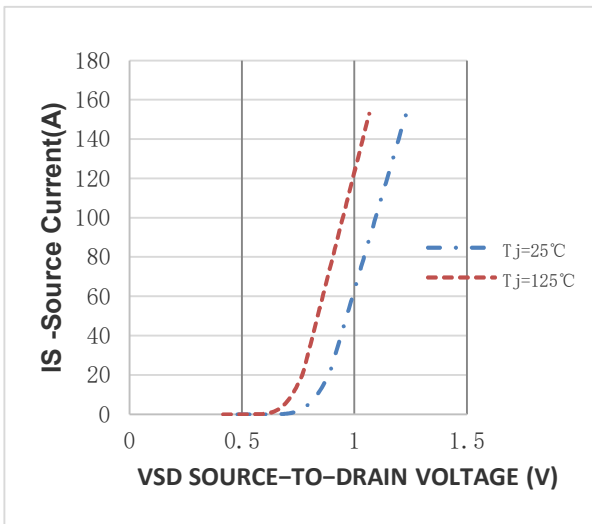

Figure 10. Transfer Characteristics

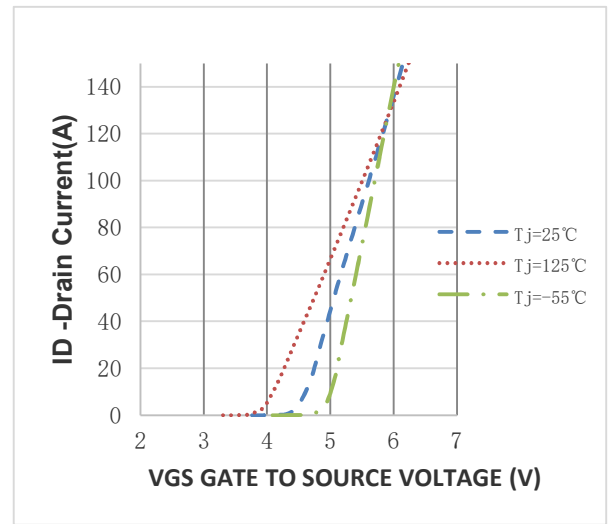

Fig.11 Safe Operating Area

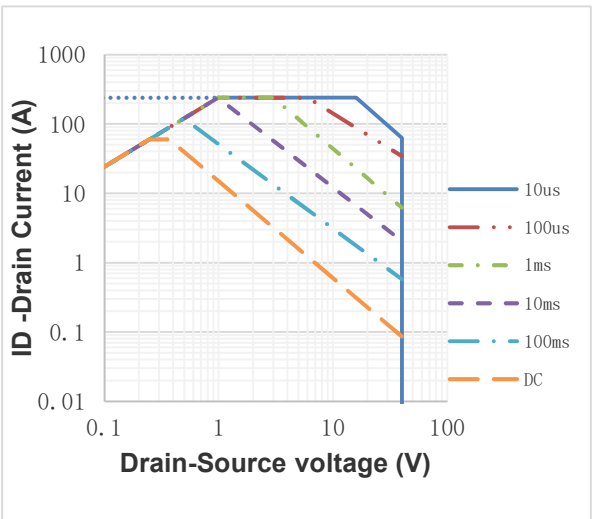
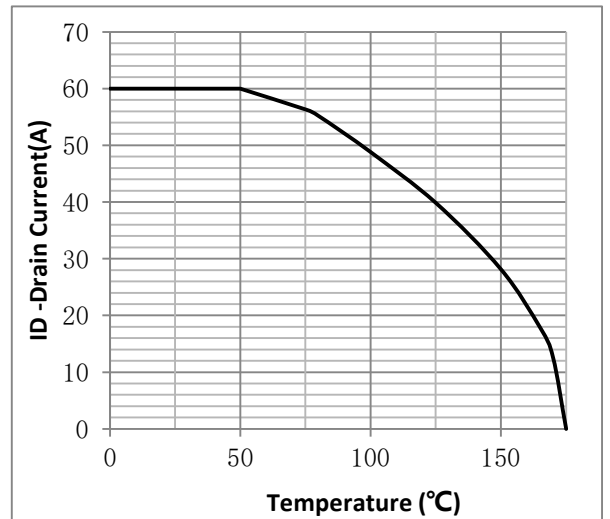
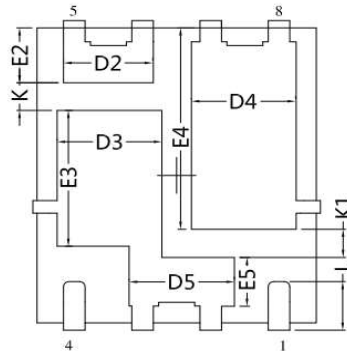
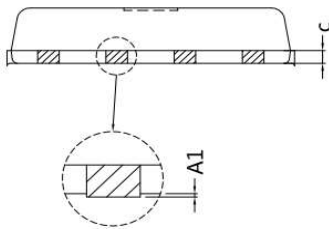
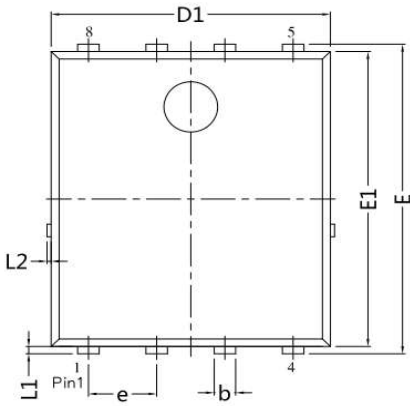

Fig.12 ID vs. Case Temperature<sup>②</sup>



•DFN5\*6 Package Outline



DIM.	MILLIMETERS		
	MIN.	NOM.	MAX.
A	1.00	1.10	1.20
A1	0	---	0.05
b	0.30	0.40	0.50
c	0.20	0.25	0.30
D1	5.10	5.20	5.30
D2	1.52	1.67	1.82
D3	1.78	1.95	2.10
D4	1.78	1.95	2.10
D5	1.81	1.96	2.11
E	6.00	6.15	6.30
E1	5.76	5.86	5.96
E2	0.94	1.09	1.24
E3	2.55	2.70	2.85
E4	3.85	4.0	4.15
E5	0.82	0.97	1.12
e	1.27 BSC		
L	0.90	0.96	1.06
L1	0.05	0.15	0.25
L2	0.02	0.08	0.15
K	0.55	---	---
K1	0.56	---	---

**Note:**

- ① Device mounted on FR-4 substrate PC board, 2oz copper, with thermal bias to bottom layer 1inch square copper plate;
- ② Practically the current will be limited by PCB, thermal design and operating temperature. VGS=10V.

**Disclaimer**

- Reproducing and modifying information of the document is prohibited without permission from ZMJ SEMICONDDUCTORS CO.,LTD.
- ZMJ SEMICONDDUCTORS CO.,LTD. reserves the rights to make changes of the content herein the document anytime without notification. Please refer to our website for the latest document.
- ZMJ SEMICONDDUCTORS CO.,LTD. disclaims any and all liability arising out of the application or use of any product including damages incidentally and consequentially occurred.
- ZMJ SEMICONDDUCTORS CO.,LTD. does not assume any and all implied warranties, including warranties of fitness for particular purpose, non-infringement and merchantability.
- Applications shown on the herein document are examples of standard use and operation. Customers are responsible in comprehending the suitable use in particular applications. ZMJ SEMICONDDUCTORS CO.,LTD. makes no representation or warranty that such applications will be suitable for the specified use without further testing or modification.
- The products shown herein are not designed and authorized for equipments relating to human life and for any applications concerning life-saving or life-sustaining, such as medical instruments, aerospace machinery et cetera. Customers using or selling these products for use in such applications do so at their own risk and agree to fully indemnify ZMJ SEMICONDDUCTORS CO.,LTD. for any damages resulting from such improper use or sale.
- Since ZMJ uses lot number as the tracking base, please provide the lot number for tracking when complaining.

Revision History

Version	Date	Change
A	2023. 2. 20	New